

A

A	B	C	D
1	F24-001	925 710	1/1

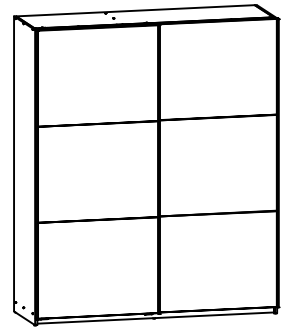

A	B	C	D
2	F24-006	925 710	1/1

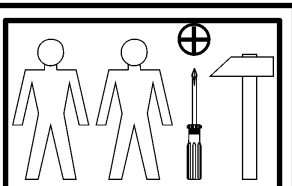
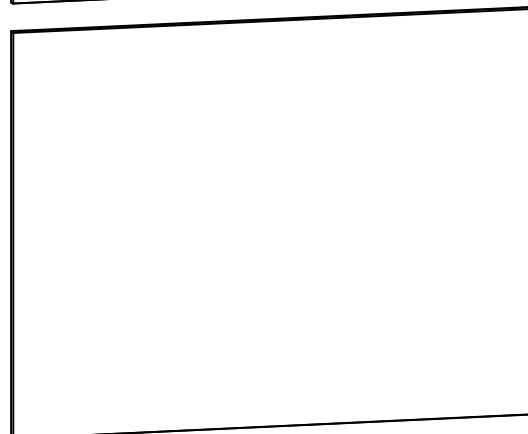
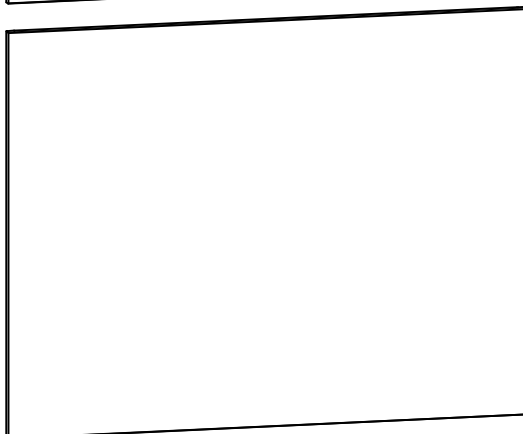
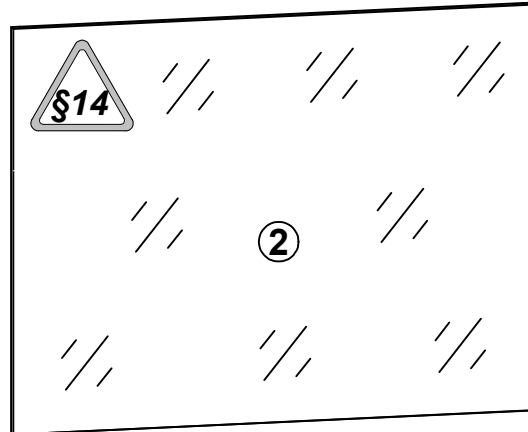
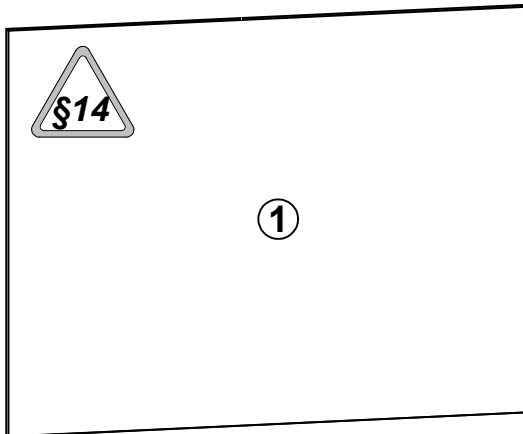

1 §2

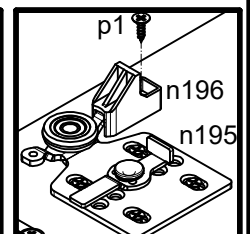
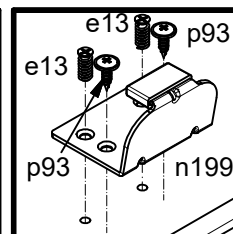
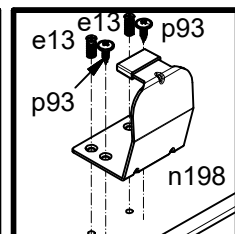
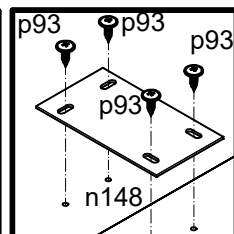
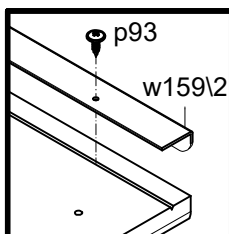
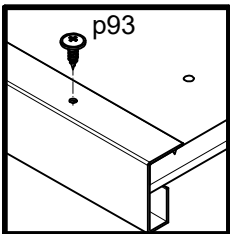
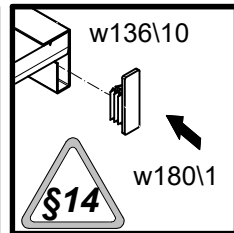
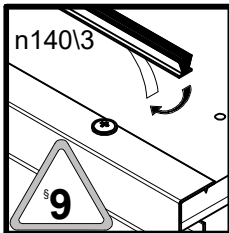
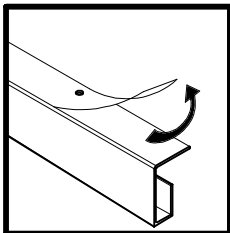
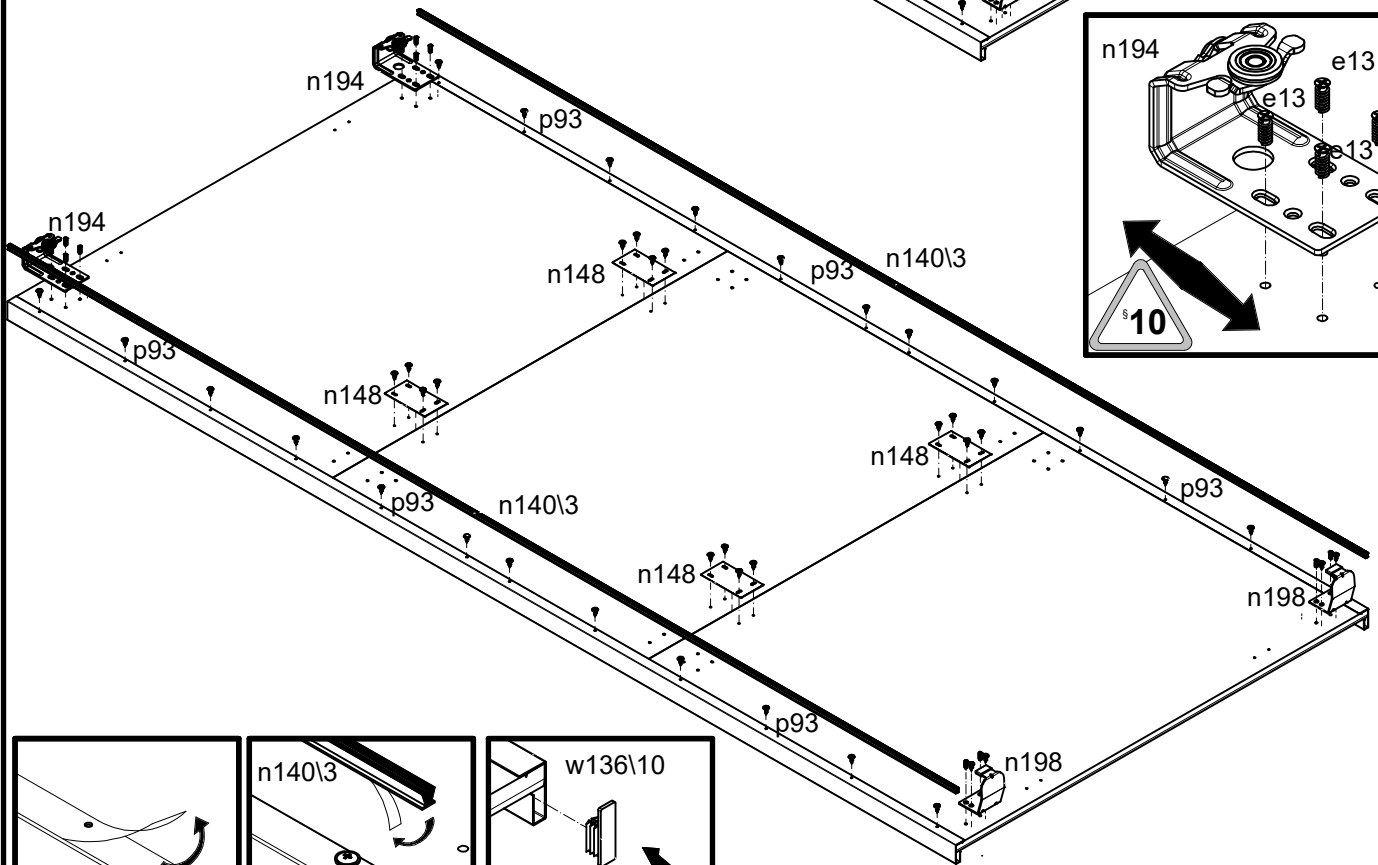
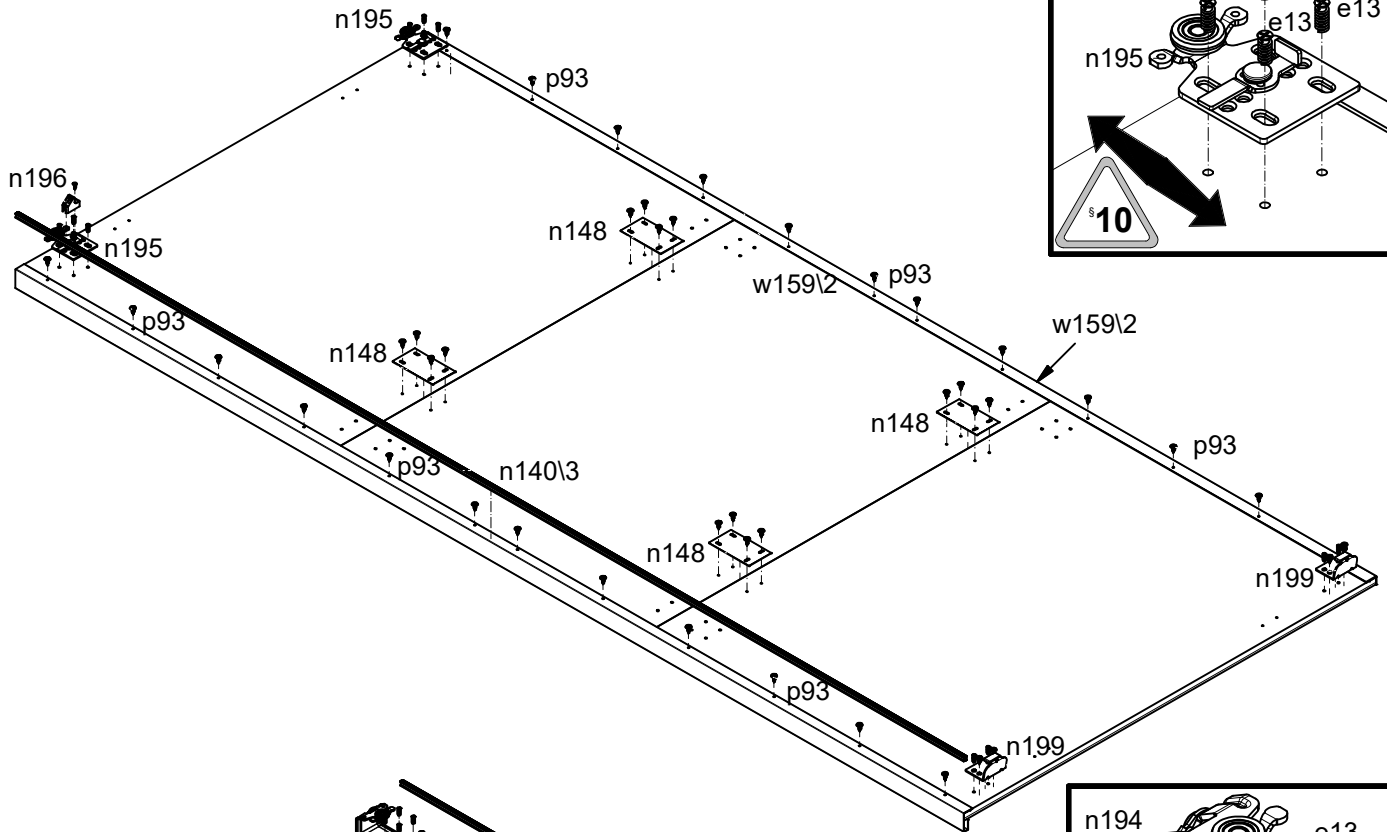

2

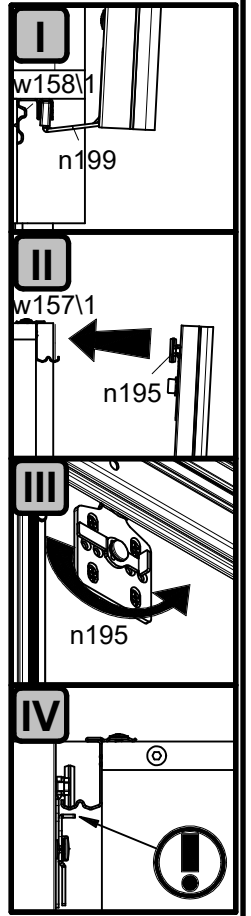
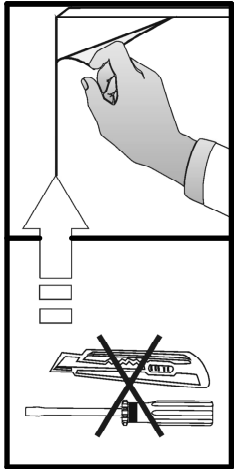
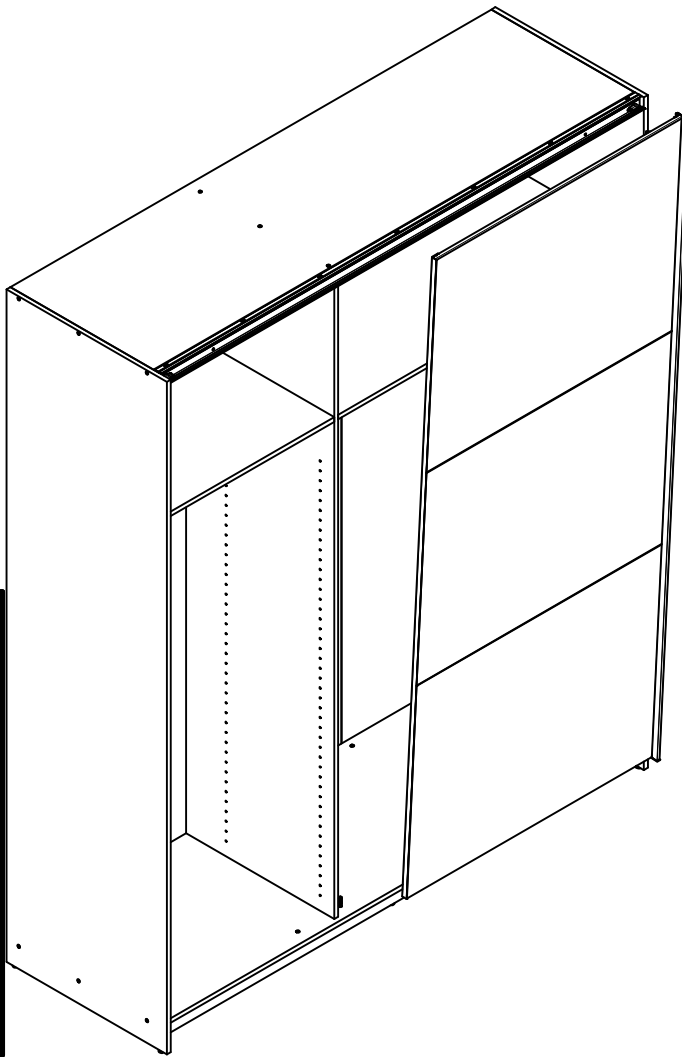

3

